



BARN OWL BOX

INSTRUCTIONS FOR ASSEMBLY

PARTS LIST:

TOP
↑

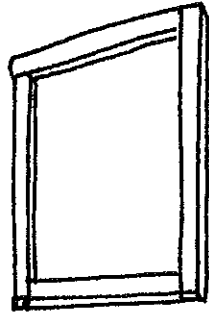

16" x 23.5"
2 SIDES

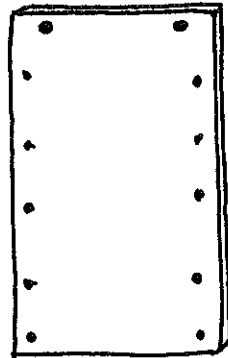

16" x 26"
1 BACK

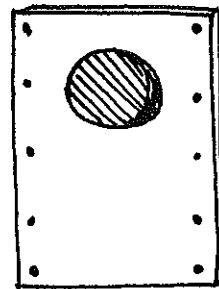

16" x 20.5"
1 FRONT

TTTTTTTTTTTT
TTTTTTTTTTTT
TTTTTTTT

TWENTYSIX PLUS
1" GALVANIZED
SCREWS

FRONT
↑

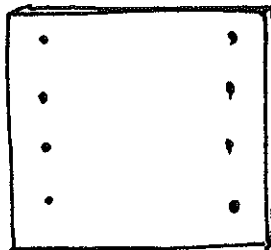

20" x 18.5"
1 TOP

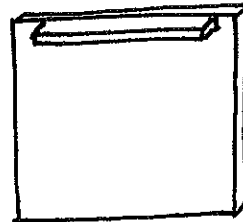

16" x 14.5"
1 BOTTOM

TOOLS FOR ASSEMBLY

1. PHILIPS HEAD SCREWDRIVER
2. FLAT SURFACE TO WORK ON
3. DIRECTIONS



INSTRUCTIONS FOR ASSEMBLY

① ATTACH 2 SIDES TO BACK. THIS STEP USES 8 SCREWS. PUT CORNER SCREWS IN FIRST TO KEEP THE BOX SQUARE. LONG PART OF SIDE ATTACHES TO THE BACK.

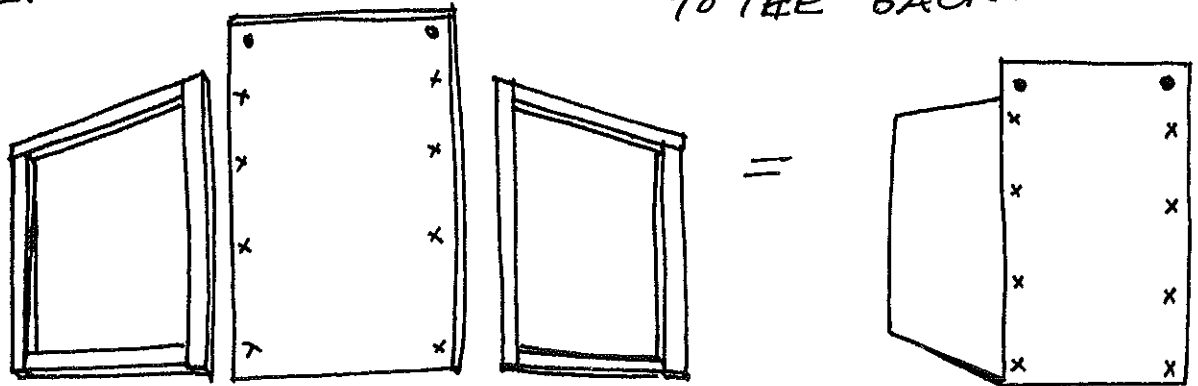

+ TTTT TTTT

BACK VIEW

② ATTACH FRONT TO BACK & SIDES. THIS STEP REQUIRES 10 SCREWS. ATTACH THE FOUR CORNER SCREWS FIRST.

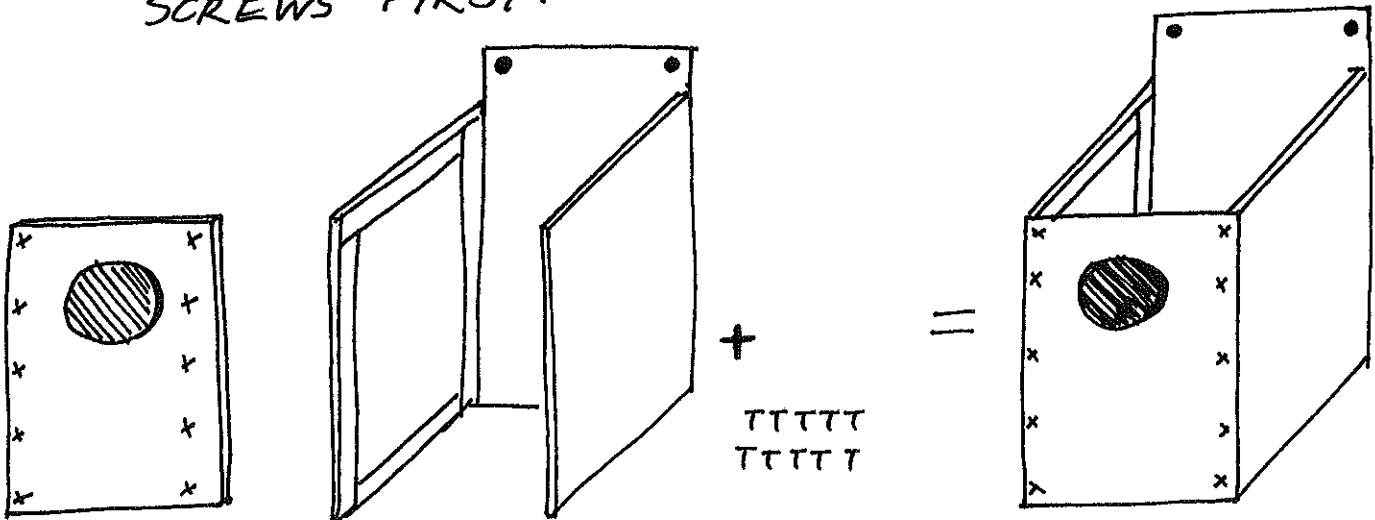

+ TTTTT
TTTTT



③ ATTACH TOP OF NESTING BOX. THIS STEP USES 8 SCREWS. DO CORNERS FIRST IN ORDER TO SQUARE BOX.

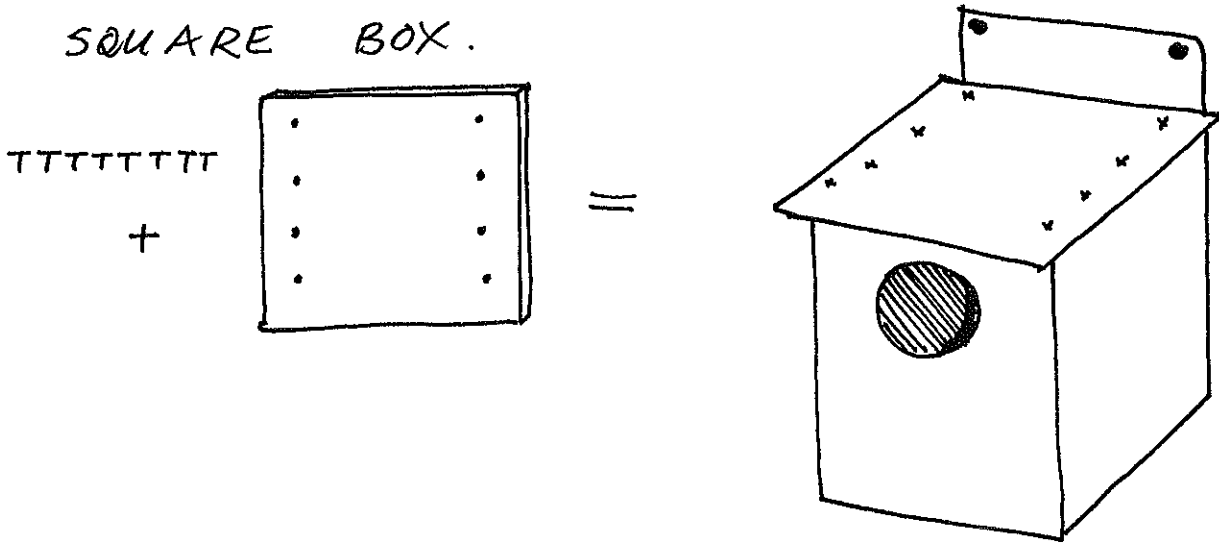

④ ATTACH BOTTOM TO NEST BOX. THIS STEP REQUIRES 8 SCREWS. FLIP BOX TO BACKSIDE. AGAIN, DO CORNERS FIRST.

